

## Sandringham 21 Wall Mounted WC Pan

### ILLUSTRATED

- V3910** Sandringham 21 wall mounted WC with horizontal outlet
- S3643** Conceala 2 cistern 4.5/3 or 4/2.6 litre dual flush valve side supply and internal overflow, alternative height plastic flushbends, no flushplate
- E1316** Seat and cover, normal close
- S4397** Contemporary flush plate dual flush, Armitage Shanks logo for Conceala 2 cisterns
- E0060** Support frame with bolts for wall hung WC pans

### OPTIONS

- S3617** Conceala 2 cistern 4.5 or 6 litre single flush syphon side supply and internal overflow plastic flushbend, long CP lever
- S3620** Conceala 2 cistern 4.5 or 6 litre single flush syphon side supply and internal overflow, alternative height plastic flushbends, no lever
- S3622** Conceala 2 cistern 6 litre single flush valve side supply and internal overflow, alternative height plastic flushbends, no push button
- S3623** Conceala 2 cistern 6 litre single flush valve bottom supply and internal overflow, alternative height plastic flushbends
- S3624** Conceala 2 cistern 6/4 litre dual flush valve top inlet and internal overflow, alternative height plastic flushbends
- S3625** Conceala 2 cistern 4/6 litre dual flush valve bottom supply and internal overflow, alternative height plastic flushbends, no flushplate
- S3621** Conceala 2 cistern 4.5 or 6 litre single flush syphon bottom supply and internal overflow, alternative height plastic flushbends no lever
- S2985** Sandringham 21 seat and cover, slow close
- E1317** Sandringham 21 seat and cover, metal hinges, normal close
- E1319** Sandringham 21 seat no cover, metal hinges, normal close
- S4395** Traditional flushing lever extended, chrome plated
- S4399** Contemporary flush plate dual flush,

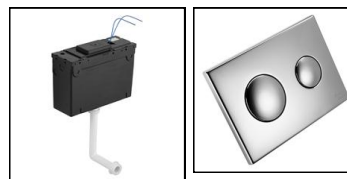
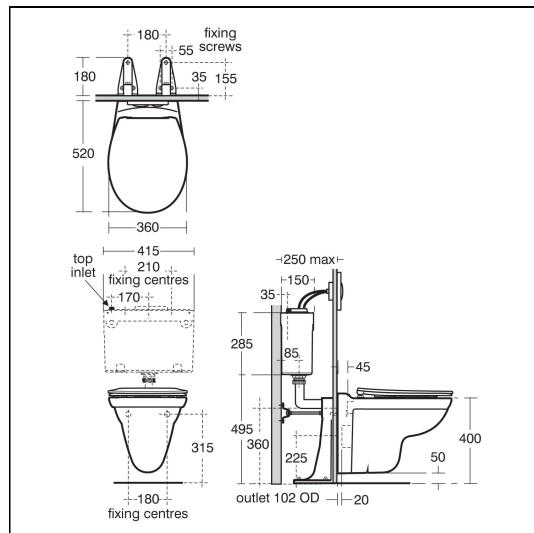

### ACCREDITATIONS



## Sandringham 21 Wall Mounted WC Pan

- S4489** unbranded for Conceala 2 cisterns  
Finger push button pneumatic, stainless steel body for 400mm maximum wall thickness
- S4491** Lever flushing Conceala 2 extended 250mm
- S4492** Lever flushing Conceala 2 extended 400mm
- S4512** Finger push button pneumatic, stainless steel for 31mm maximum thickness partition
- E9325** In-wall system 6/3 or 4.5/3 litre flush for WC, 880mm high, mechanical top or front operation flushplate
- E9324** In-wall system 6/3 or 4.5/3 litre flush for WC, 1100mm high, mechanical front operation flushplate

### FEATURES



### ILLUSTRATED PRODUCT DETAILS





#### Weights

- V3910** 15.09 KG
- S3643** 2.70 KG
- E1316** 2.17 KG
- S4397** 1.10 KG
- E0060** 4.28 KG

#### Materials

- V3910** Vitreous China
- S3643** Plastic
- E1316** Plastic
- S4397** Chrome Plated Plastic
- E0060** Metal

#### Finishes

- V3910**  White (01)
- S3643**  Neutral / No Finish (67)
- E1316**  White (01)
- S4397**  Chrome (AA)
- E0060**  Neutral / No Finish (67)

#### Capacity

- S3643** 4 litres

### FINISH OPTIONS



(AA) Chrome

(BX) Brushed Nickel

#### Standards

Vitreous china to BS 3402, BS EN 997 & BS EN 33

#### Special Notes

WC fixed to support brackets with bolts supplied. Joint sealed with waterproof sealant (not supplied) Suitable for in-wall WC frame.